

TLM-8

User's Guide

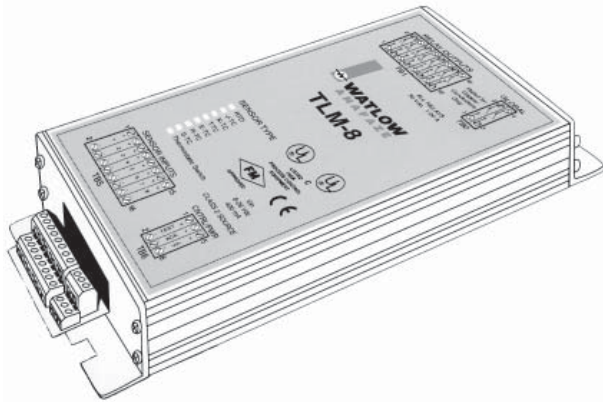

Features and Description

The TLM-8 is a multi-zone temperature limit switch. For thermal system safety, the TLM-8 can satisfy the requirement for independent temperature monitoring. The TLM-8's alarm outputs interface with visual and audible alarm devices, or they can initiate safe shut-down of equipment.

The TLM-8 has the following features:

- Multi-channel temperature monitoring
- Latching alarms
- Isolated sensor inputs
- Support for various thermocouples, RTDs, and thermostats
- Diagnostic test mode
- Open-sensor fail-safe
- Compact and easy to install
- LED indicator lights

Up to eight temperature zones may be monitored. If any temperature exceeds a trip point, the TLM-8 generates an alarm output. The alarm output may be used for safety shutdown or annunciation. Alarm outputs remain active until two conditions are met in sequence: the temperature drops below the trip point and alarms are acknowledged. Built-in indicator lights show power and alarm states.

The TLM-8 accepts up to eight thermocouple, RTD or thermostatic switch temperature sensors. There are two global alarm relay outputs. The TLM-8 is also available with eight channel-alarm relays in addition to the two global relay outputs. If all temperatures are below the trip point, the TLM-8's relay outputs are closed. When alarms activate, the relay contacts open.

Part No. 0600-2150-2000 Rev. D

Revised: October 2007

© 2004, 2007 Watlow Electric and Manufacturing Company. All rights reserved.



Watlow Controls
1241 Bundy Blvd., Winona, MN 55987

Customer Service
Phone: 1-800-414-4299
Fax: 1-800-445-8992

Technical Support
Phone: (507) 494-5656
Fax: (507) 452-4507

E-mail: wintechsupport@watlow.com

Relays that open on alarm are consistent with fail safe designs and practices. Alarms are acknowledged with an optically isolated, digital input. Another isolated digital input is used for testing, by simulating alarms on all channels.

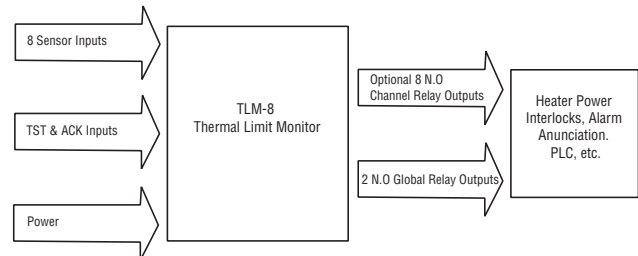

TLM-8 System Diagram

Warranty

The TLM-8 is manufactured by ISO 9001-registered processes and is backed by a three-year warranty to the first purchaser for use, providing that the units have not been misapplied. Since Watlow has no control over their use, and sometimes misuse, we cannot guarantee against failure. Watlow's obligations hereunder, at Watlow's option, are limited to replacement, repair, or refund of purchase price, and parts which upon examination prove to be defective within the warranty period specified. This warranty does not apply to damage resulting from transportation, alteration, misuse or abuse. The purchaser must use Watlow parts to maintain all listed ratings.

Mounting the TLM-8

The TLM-8 mounts directly to a panel or on a DIN rail depending on the mounting style ordered.

DIN Rail Mounting

The TLM-8 simply snaps onto a standard 35 mm DIN rail. Place the hook side of the mounting mechanisms over one of the DIN rail edges and snap the assembly over the other edge.

DIN Rail Removal

Remove the TLM-8 from the DIN rail by placing a flat blade screw driver through the slot in the end plate, hook the blade into the snap latch and pry the snap latch away from the DIN rail edge. Repeat for the other side.

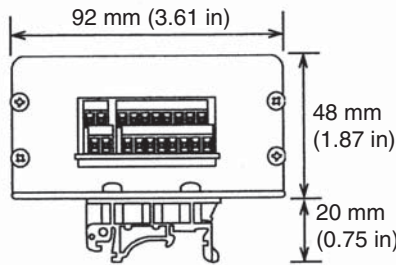

End View

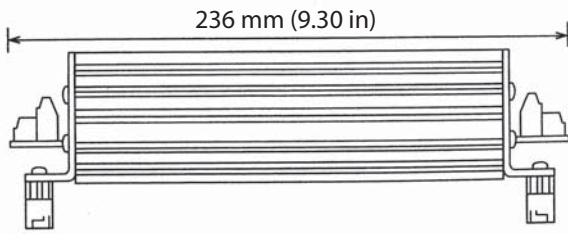

Side View

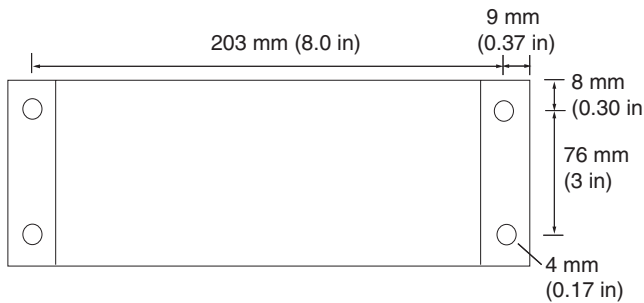

Mounting Hole Dimensions

Panel Mounting

The four mounting holes will accommodate up to 3.8 mm (#6) screws or bolts.

Wiring Recommendations

TB5 Sensor Inputs

| Sensor Input | Terminals | |
|--------------|-----------|----|
| | + | - |
| 1 | 1 | 2 |
| 2 | 3 | 4 |
| 3 | 5 | 6 |
| 4 | 7 | 8 |
| 5 | 9 | 10 |
| 6 | 11 | 12 |
| 7 | 13 | 14 |
| 8 | 15 | 16 |

TB6 Power and Digital Inputs

| Function | Terminals | |
|-------------|-----------|---|
| | + | - |
| Test | 1 | 2 |
| Acknowledge | 3 | 4 |
| Power | 5 | 6 |

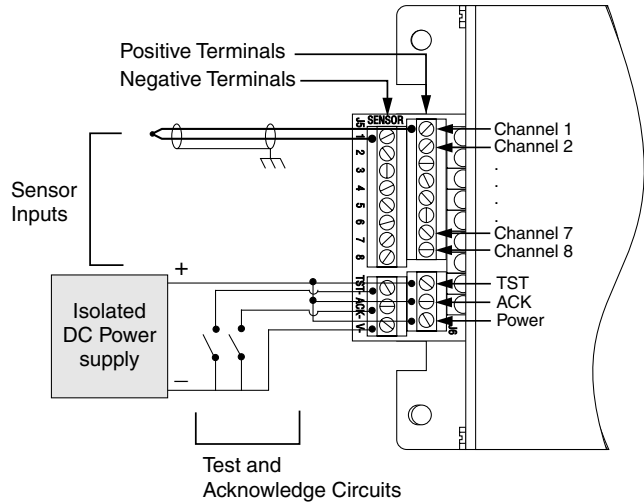

Input Wiring

DC Power Supply

The TLM-8 accepts to 24V_{DC} (dc) power input from a class 2 power supply.

Test Input

The test input, TST, is a level-triggered digital input. It is activated after the input signal is applied for at least 1 second (filter). The input signal may be generated by a contact closure or controller output. The input accepts a 5 to 30V_{DC} (dc) signal. The circuit contains a resistor and optical isolator.

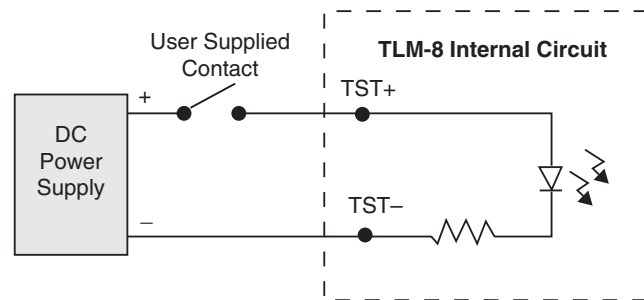

Test Input

Acknowledge Input

The acknowledge input, ACK is an edge-triggered digital input. The input accepts a 5 to 30V_{DC} (dc) signal. The circuit contains a resistor and optical isolator. If you are using a push button to generate the input signal, momentary contacts are recommended because the input is edge-triggered.

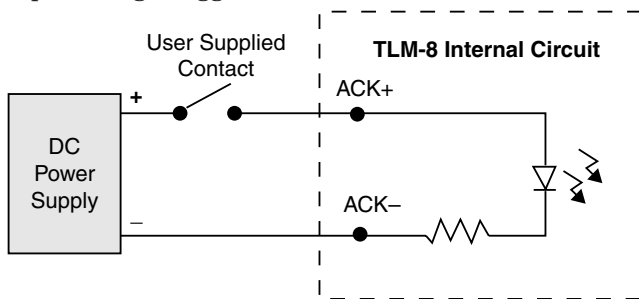

Acknowledge Input

Thermocouple and RTD Inputs

Be sure to use the type of sensor that matches your TLM-8; the input type is noted on the label.

Thermostatic Switch Inputs

When using thermostatic switch (thermostat) inputs, TLM-8 trip points can be set externally. The TLM-8 should be configured for thermostatic switches. Use normally-closed thermostats that open at or above the trip point.

Unused Inputs

If a sensor input is not used, short the positive and negative input terminals.

TB1 Channel Relay Outputs

| Relay Output | Terminals |
|--------------|-----------|
| 1 | 1, 2 |
| 2 | 3, 4 |
| 3 | 5, 6 |
| 4 | 7, 8 |
| 5 | 9, 10 |
| 6 | 11, 12 |
| 7 | 13, 14 |
| 8 | 15, 16 |

TB2 Global Relay Outputs

| Global Alarm Output | Terminals |
|---------------------|-----------|
| 1 | 1, 2 |
| 2 | 3, 4 |

⚡ WARNING:

You must connect the thermocouple to the input terminal blocks correctly. If the inputs are reversed, the sensor may be unable to generate an alarm. This could result in a fire or other accident leading to loss of property or lives.

⚡ CAUTION:

To protect the alarm relay contacts when connected to an inductive load, use catch diodes for dc loads and snubbers on ac or dc loads. For dc applications select a diode with a reverse breakdown voltage 10 times the applied voltage and forward load current.

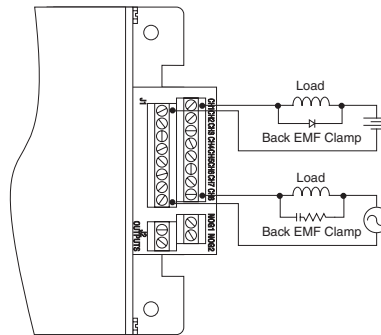

Wiring Recommendations for relay outputs

⚡ CAUTION:

To minimize the power dissipated by the internal circuits and ensure temperature accuracy, apply voltage to the ACK and TST inputs only when intending to test the TLM-8 or acknowledge alarms. At other times the applied signal should be 0V_{DC} (dc).

NOTE: To avoid interference with sensor readings, separate sensor and power wiring.

NOTE: This device is designed for indoor use only.

NOTE: Use only copper conductors for power and signals other than thermocouples.

NOTE: Previous versions of the TLM-8 recommended earth grounding the unit's case, but the current version does not require the case to be earth grounded.

NOTE: Alarm outputs and indicators are latched until the condition is corrected and the alarm is acknowledged, as long as the TLM-8 remains powered. If power is cycled to the unit, it will evaluate the limits again.

Using the TLM-8

Sensor Types

Sensor types for the TLM-8 are factory configured; the type of sensor for your TLM-8 is marked on the label.

Trip Points

Your TLM-8 has been factory configured with trip points per your specification. Accuracy of a trip point is $\pm 5\%$ for TLM-8s with model numbers starting with “TLME.” For example, 5% of a 200°C trip point is 10°. So a 200°C trip point would trigger between 190 and 210°C.

Reading Trip Points

The trip points for TLM-8s with model numbers starting with “TLME” are encoded in the part number. To determine trip points from a part number, see the section, TLM-8 Part Numbers. The trip points for TLM-8s with model numbers starting with “TLMC” are listed on the label.

Alarms and Acknowledgment

When the TLM-8 is powered and there is no alarm, the alarm relay contacts are held closed. When a channel’s temperature exceeds the trip point or the sensor fails, that channel’s indicator light is illuminated and the global alarm relay contacts open.

When the TLM-8 is configured with the eight, optional channel alarm relays and a channel’s temperature exceeds its trip point, both the global alarm relay and the corresponding channel alarm relay open.

All alarms are acknowledged with the ACK input. An external device provides the logic signal to the ACK input. The ACK input activates on the trailing edge of the input signal. The input must be high for at least 20 milliseconds; when the input signal transitions to low, alarms are acknowledged. Allow up to 3.5 seconds after acknowledging the alarms for the relays to close.

Acknowledging alarms before the temperature drops below the trip point or before a failed sensor is repaired will have no effect. Wait until the temperature drops below the trip point before acknowledging alarms. When the alarms are successfully acknowledged, the alarm indicator lights turn off and the alarm relay contacts close.

Reading the Indicator Lights

The alarm status of each channel is indicated by the red indicator lights adjacent to the sensor input terminal block. A channel indicator light turns on when the associated channel goes into alarm. If the TLM-8 is configured with channel relays, this indicator light reflects the status of the associated channel relay. The indicator light will remain on until the acknowledge input, ACK, is activated after the temperature drops below the trip point.

The green power light indicates the TLM-8 has power.

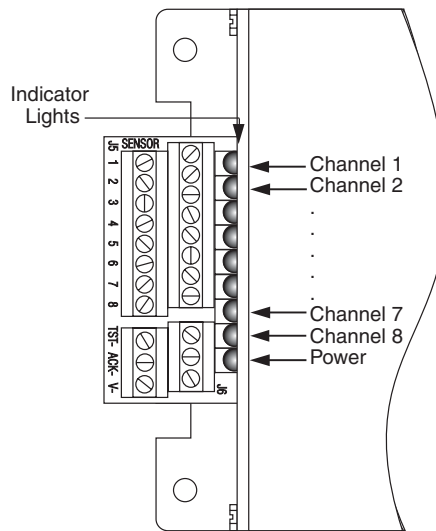

Alarm Status Indicator Lights

Testing the Outputs

The TLM-8 TST digital input allows users to simulate excessive temperature on all channels. An external device — switch or controller — provides the logic signal to the test, TST, input. All channels go into alarm which can be easily verified by the channel indicator lights. Use the following procedure to test the TLM-8:

1. Activate the TST input for at least 1 second. All alarms and indicator lights should activate.
2. Deactivate the TST input.
3. Activate the ACK input for at least 20 milliseconds.
4. Deactivate the ACK input. All alarms should deactivate within 3.5 seconds.

Changing Trip Points

To change a trip point on the TLM-8, obtain an RMA number from your supplier and return the TLM-8 for adjustment.

Maintenance

Over-temperature conditions may not occur regularly. To test the TLM-8’s outputs, use the procedure in the section “Testing the Outputs” to force the TLM-8 to simulate alarm conditions on all channels.

To test trip point values and other system components, use a thermocouple calibrator or other appropriate means to simulate a sensor input above the trip point.

Application Example

In the following example, a TLM-8 monitors temperatures and provides independent safety shutdown, alarm annunciation and acknowledgment. A multi-loop controller, CLS200 or MLS300, is used for primary control. The TLM-8 has its own set of thermocouples to monitor temperatures independent of the controller. If a temperature exceeds a trip point configured in the TLM-8, then power to the heater is turned off by a TLM-8 controlled relay, and the System OK indicator light is turned off. After the temperature drops and the cause of the alarm has been corrected, an operator acknowledges the alarm. The primary controller resumes control of the loop(s).

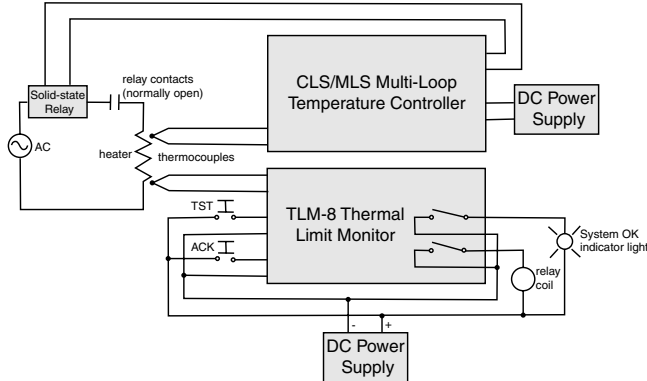

Example Schematic

NOTE: Relay contacts are illustrated in the unpowered or alarmed state.



Declaration of Conformity

Series TLM-8
Watlow Winona, Inc.
1241 Bundy Blvd.
Winona, MN 55987 USA

Declares that the following product:

| | |
|--------------------------|---|
| Designation: | Series TLM-8 |
| Model Numbers: | TLM (C, E or P)(0 - 6)(0 or 1)(0 - 9)(additional letters or numbers indicating setpoint temperatures. |
| Classification: | Temperature control, Installation Category II, Pollution degree 2 |
| Rated Voltage and Power: | Control 12 to 24 V= (dc) 400 mA maximum |

Note: Use of external CE approved ELV (UL Class 2) power supply required.*

Meets the essential requirements of the following European Union Directives by using the relevant standards show below to indicate compliance.

| | | | |
|----------------|------|--|---|
| | | 2004/108/EC Electromagnetic Compatibility Directive | |
| EN 61326 | 1997 | A1:1998 A2:2002 A3:2004 | Electrical equipment for measurement, control and laboratory use - EMC requirements (Industrial Immunity, Class B Emissions). |
| EN 61000-4-2 | 1995 | A2, 2001 | Electrostatic Discharge Immunity |
| EN 61000-4-3 | 2002 | | Radiated Field Immunity |
| EN 61000-4-4 | 2004 | | Electrical Fast-Transient / Burst Immunity |
| EN 61000-4-5* | 1995 | A2, 2001 | Surge Immunity |
| EN 61000-4-6 | 1996 | A3, 2005 | Conducted Immunity |
| EN 61000-4-11* | 2004 | | Voltage Dips, Short Interruptions and Voltage Variations Immunity |
| EN 61000-3-2* | 2001 | ED.2 | Harmonic Current Emissions |
| EN 61000-3-3* | 1995 | A2:2002 | Voltage Fluctuations and Flicker |

| | | | |
|------------|------|--|---|
| | | 73/23/EEC Low-Voltage Directive | |
| EN 61010-1 | 2001 | | Safety Requirements of electrical equipment for measurement, control and laboratory use. Part 1: General requirements |

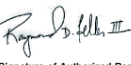
| | | | |
|--|--|--|--|
| | | 2002/96/EC WEEE Directive  | |
| | | Equipment Requires Recycling | |
| Raymond D. Feller III | | Winona, Minnesota, USA | |
| Name of Authorized Representative | | Place of Issue | |
| General Manager | | August 2007 | |
| Title of Authorized Representative | | Date of Issue | |
|  | | | |
| Signature of Authorized Representative | | | |

Declaration of Conformity

Specifications

Analog Inputs

Sensor input channels: 8

Sensor Types and Trip Point Ranges:

- 2-Wire 100 Ω Platinum RTD DIN curve (385): -100 to 850°C (-148 to 1,562°F)
- E Thermocouple: 100 to 801°C (212 to 1,474°F)
- K Thermocouple: 100 to 1,205°C (212 to 2,201°F)
- S Thermocouple: 500 to 1,711°C (932 to 3,112°F)
- J Thermocouple: 100 to 754°C (212 to 1,389°F)
- R Thermocouple: 500 to 1,720°C (932 to 3,128°F)
- T Thermocouple: 100 to 384°C (212 to 723°F)
- Thermostatic switch

At actual temperatures of -100°C (-148°F) or less, nuisance alarms may occur.

Accuracy for trip points above 100°C (212°F):

- For part numbers starting with "TLME," $\pm 5\%$ of trip point.
- For part numbers starting with "TLMC," see below.

| Sensor (s) | Trip Point Accuracy Ambient: 15 to 35°C (59 to 95°F) | Trip Point Accuracy Ambient: 0 to 60°C (32 to 140°F) |
|-----------------|--|--|
| J, K, E, T, RTD | $\pm 0.5\%$ of trip point and $\pm 2^\circ\text{C}$ (3.2°F) | $\pm 0.5\%$ of trip point and $\pm 4^\circ\text{C}$ (7.2°F) |
| S, R | $\pm 0.5\%$ of trip point and $\pm 3^\circ\text{C}$ (5.4°F) | $\pm 0.5\%$ of trip point and $\pm 5^\circ\text{C}$ (9°F) |

Repeatability: better than 5°C (9°F) or accuracy for trip point, whichever is less.

Input filter: 1 second (minimum time the over-temperature condition exists before the output responds)

Isolation:

- Common Mode: $\pm 10\text{V}$ ~ (ac) or V ~ (dc)
(Input to analog common)
- Input-to-Input: $\pm 10\text{V}$ ~ (ac) or V ~ (dc)
- Input-to-Frame Ground: $\pm 500\text{V}$ ~ (ac) or V ~ (dc)

ACK Input

Function: alarm acknowledge

Type: digital input

Activation: edge triggered (on to off transition)

Filter: 20 milliseconds

Maximum time to reset relays: 3.5 seconds

Maximum time signal should be held high: 5 seconds

Isolation: optical

Voltage and current: 5 to 30V~ (dc); 2 mA @ 5V~ (dc); 19 mA @ 30V~ (dc)

Impedance: 1.5 k Ω

TST Input

Function: test

Type: digital input

Activation: level triggered (signal high)

Filter: must be active for 1 second for valid simulation

Maximum time signal should be held high: 5 seconds

Isolation: optical

Voltage and current: 5 to 30V~ (dc); 2 mA @ 5V~ (dc); 19 mA @ 30V~ (dc)

Impedance: 1.5 k Ω

Electromechanical Alarm Relays

Contact arrangement: open in power-off condition

Contact action: latch open in alarm condition

Maximum contact rating: 1 A @ 30V~ (dc)

Indicator Lights

Alarm status: 8 red

Power: 1 green

Dimensions

Length: 236 mm (9.30 in.)

Width: 92 mm (3.61 in.)

Depth: 48 mm (1.87 in.)

DIN rail mount: add 20 mm (0.75 in.) to depth

Power Requirements

Nominal voltage: 12 to 24V~ (dc)

Absolute voltage: 10 to 27V~ (dc)

Power: 3.2 watts

Requires: Class 2 power supply

Terminal Blocks

Type: Removable

Torque: 0.33 to 0.35 Nm (2.9 to 3.1 in-lbs.)

Wire Gauge: 26 to 18 AWG

Environmental

Operating ambient temperature: 0 to 60°C (32 to 140°F)

Storage ambient temperature: -20 to 100°C (-4 to 212°F)

Relative humidity: 0 to 95%, non condensing

Agency Approvals / Compliance

UL, cUL Listed (File No. E185611)

- Process Control Equipment UL 61010
- Process Control Equipment C22.2 #61010-1

FM

- Temperature Limit Switches – Non Indicating Class 3545
- Temperature Supervisory Switch Class 3545

CE

- Low Voltage Directive (LVD) 73/23/EEC
- Electromagnetic Compatibility Directive (EMC) 2004/108/EC

TLM-8 Part Numbers

Use the tables to determine the characteristics of your TLM-8 based on its part number.

Standard TLM-8 Part Number

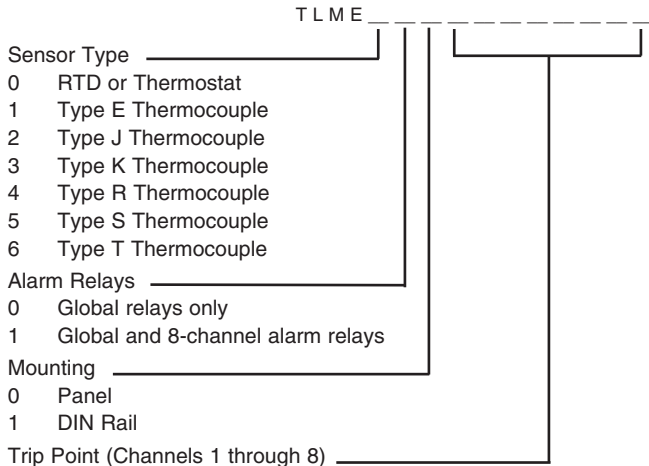

(See Trip Point table below.)

Custom TLM-8 Part Number

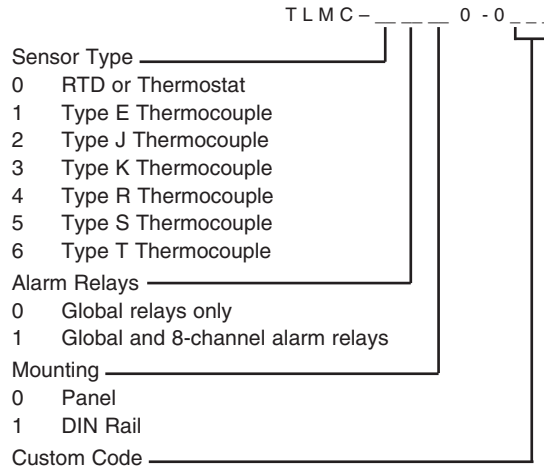

3-digit code assigned by factory (See label on unit for trip-point values.)

Trip Points

| RTD | | E Thermocouple | | J Thermocouple | | K Thermocouple | | R Thermocouple | | S Thermocouple | | T Thermocouple | |
|-----------------|------------|-----------------|------------|-----------------|------------|-------------------|------------|-------------------|------------|-------------------|------------|----------------|------------|
| Temperature | Trip Point | Temperature | Trip Point | Temperature | Trip Point | Temperature | Trip Point | Temperature | Trip Point | Temperature | Trip Point | Temperature | Trip Point |
| Unused Input | A | Unused Input | A | Unused Input | A | Unused Input | A | Unused Input | A | Unused Input | A | Unused Input | A |
| 103°C (217°F) | B | 101°C (214°F) | B | 100°C (212°F) | B | 100°C (212°F) | B | 501°C (934°F) | B | 506°C (943°F) | B | 100°C (212°F) | B |
| 121°C (250°F) | C | 202°C (396°F) | C | 152°C (307°F) | C | 150°C (302°F) | C | 602°C (1,116°F) | C | 601°C (1,114°F) | C | 202°C (396°F) | C |
| 151°C (304°F) | D | 302°C (576°F) | D | 202°C (396°F) | D | 200°C (392°F) | D | 708°C (1,306°F) | D | 700°C (1,292°F) | D | 291°C (556°F) | D |
| 215°C (419°F) | E | 403°C (756°F) | E | 251°C (484°F) | E | 252°C (486°F) | E | 800°C (1,472°F) | E | 810°C (1,490°F) | E | 384°C (723°F) | E |
| 324°C (615°F) | F | 502°C (936°F) | F | 302°C (576°F) | F | 303°C (577°F) | F | 903°C (1,657°F) | F | 902°C (1,656°F) | F | | |
| 404°C (759°F) | G | 600°C (1,112°F) | G | 350°C (662°F) | G | 353°C (667°F) | G | 999°C (1,830°F) | G | 1,005°C (1,841°F) | G | | |
| 478°C (892°F) | H | 702°C (1,296°F) | H | 402°C (756°F) | H | 401°C (754°F) | H | 1,100°C (2,012°F) | H | 1,110°C (2,030°F) | H | | |
| 584°C (1,083°F) | I | 801°C (1,474°F) | I | 450°C (842°F) | I | 455°C (851°F) | I | 1,206°C (2,203°F) | I | 1,210°C (2,210°F) | I | | |
| 708°C (1,306°F) | J | | | 502°C (936°F) | J | 504°C (939°F) | J | 1,306°C (2,383°F) | J | 1,313°C (2,395°F) | J | | |
| 824°C (1,515°F) | K | | | 554°C (1,027°F) | K | 556°C (1,033°F) | K | 1,410°C (2,570°F) | K | 1,404°C (2,559°F) | K | | |
| Thermostat | K | | | 600°C (1,112°F) | L | 603°C (1,117°F) | L | 1,497°C (2,727°F) | L | 1,500°C (2,732°F) | L | | |
| | | | | 653°C (1,207°F) | M | 651°C (1,204°F) | M | 1,593°C (2,899°F) | M | 1,600°C (2,912°F) | M | | |
| | | | | 704°C (1,299°F) | N | 701°C (1,294°F) | N | 1,720°C (3,128°F) | N | 1,711°C (3,112°F) | N | | |
| | | | | 754°C (1,389°F) | O | 753°C (1,387°F) | O | | | | | | |
| | | | | | | 807°C (1,485°F) | P | | | | | | |
| | | | | | | 851°C (1,564°F) | Q | | | | | | |
| | | | | | | 907°C (1,665°F) | R | | | | | | |
| | | | | | | 952°C (1,746°F) | S | | | | | | |
| | | | | | | 998°C (1,828°F) | T | | | | | | |
| | | | | | | 1,057°C (1,935°F) | U | | | | | | |
| | | | | | | 1,101°C (2,014°F) | V | | | | | | |
| | | | | | | 1,157°C (2,115°F) | W | | | | | | |
| | | | | | | 1,205°C (2,201°F) | X | | | | | | |

How to Reach Us

Corporate Headquarters

Watlow Electric Manufacturing Company
12001 Lackland Road
St. Louis, MO 63146
Sales: 1-800-WATLOW2
Manufacturing Support: 1-800-4WATLOW
Email: info@watlow.com
Website: www.watlow.com
From outside the USA and Canada:
Tel: +1 (314) 878-4600
Fax: +1 (314) 878-6814

Latin America

Watlow de México S.A. de C.V.
Av. Fundación No. 5
Col. Parques Industriales
Querétaro, Qro. CP-76130
Mexico
Tel: +52 442 217-6235
Fax: +52 442 217-6403

Europe

Watlow France SARL
Immeuble Somag
16, Rue Ampère
95307 Cergy-Pontoise CEDEX
France
Tel: + 33 (0)1 30 73 24 25
Fax: + 33 (0)1 30 73 28 75
Email: info@watlow.fr
Website: www.watlow.fr

Watlow GmbH
Postfach 11 65, Lauchwasenstr. 1
D-76709 Kronau
Germany
Tel: +49 (0) 7253 9400-0
Fax: +49 (0) 7253 9400-900
Email: info@watlow.de
Website: www.watlow.de

Watlow Italy S.r.l.
Viale Italia 52/54
20094 Corsico MI
Italy
Tel: +39 024588841
Fax: +39 0245869954
Email: italyinfo@watlow.com
Website: www.watlow.it

Watlow Ibérica, S.L.U.
CME - Avda. de la Vía Láctea, s/n. Oficina 24
28830 - San Fernando de Henares Madrid
Spain
Tel: +34.91.675.1292
Fax: +34.91.648.7380
Email: info@watlow.es
Website: www.watlow.es

Watlow
Storgatan 24
302 43 Halmstad
Sweden
Tel: + 46 (0)35 27 11 66
Fax: +46 (0)35 27 11 67
Email: info@watlow.se
Website: www.watlow.se

Watlow UK Ltd.
Linby Industrial Estate
Linby, Nottingham, NG15 8AA
United Kingdom
Telephone: (0) 115 964 0777
Fax: (0) 115 964 0071
Email: info@watlow.co.uk
Website: www.watlow.co.uk
From outside The United Kingdom:
Tel: +44 115 964 0777
Fax: +44 115 964 0071

Asia and Pacific

Watlow Singapore Pte Ltd.
16 Ayer Rajah Crescent,
#06-03/04,
Singapore 139965
Tel: +65 6773 9488 Fax: +65 6778 0323
Email: info@watlow.com.sg Website: www.watlow.com.sg

Watlow Australia Pty., Ltd.
4/57 Sharps Road
Tullamarine, VIC 3043
Australia
Tel: +61 3 9335 6449
Fax: +61 3 9330 3566
Website: www.watlow.com

瓦特隆电子科技(上海)有限公司
(销售办事处)
上海市浦东新区张江工业园区碧波路115号572弄22棟 *
邮编: 201203
电话: 86 21 5080-0902 传真: 86 21 5080-0906
电子邮箱: info@watlow.cn Website: www.watlow.cn

Watlow Electric Manufacturing (Shanghai) Company
115-22#, 572nd Lane, Bibo Road, Zhangjiang High-Tech Park,
Shanghai, PRC 201203
People's Republic of China
Tel: +86 21 5080-0902 Fax: +86 21 5080-0906
Email: info@watlow.cn Website: www.watlow.cn

ワトロー・ジャパン株式会社
〒101-0047 東京都千代田区内神田1-14-4
四国ビル別館9階
Tel: 03-3518-6630 Fax: 03-3518-6632
Email: infoj@watlow.com Website: www.watlow.co.jp

Watlow Japan Ltd.
1-14-4 Uchikanda, Chiyoda-Ku
Tokyo 101-0047
Japan
Tel: +81-3-3518-6630 Fax: +81-3-3518-6632
Email: infoj@watlow.com Website: www.watlow.co.jp

Watlow Korea Co., Ltd.
#1406, E&C Dream Tower, 46, Yangpyeongdong-3ga
Yeongdeungpo-gu, Seoul 150-103
Republic of Korea
Tel: +82 (2) 2628-5770 Fax: +82 (2) 2628-5771
Website: www.watlow.co.kr

Watlow Malaysia Sdn Bhd
No. 14-3 Jalan 2/114
Kuchai Business Centre
Jalan Kuchai Lama
58200 Kuala Lumpur
Malaysia
Tel: +60 3 7980 7741 Fax: +60 3 7980 7739

瓦特龍電機股份有限公司
80143 高雄市前金區七賢二路189號 10樓之一
電話: 07-2885168 傳真: 07-2885568

Watlow Electric Taiwan Corporation
10F-1 No.189 Chi-Shen 2nd Road Kaohsiung 80143
Taiwan
Tel: +886-7-2885168 Fax: +886-7-2885568

Your Authorized Watlow Distributor

**TOTAL
CUSTOMER
SATISFACTION**
3 Year Warranty